



俊伸有限公司

SIMPLE AND SUSTAINABLE

PET 厚壁瓶罐

PET HEAVY WALL BOTTLES AND JARS

100% PCR PET 環保厚壁瓶罐

100% PCR PET HEAVY WALL BOTTLES AND JARS

各式材質真空瓶

AIRLESS BOTTLES





俊伸有限公司
EPOPACK CO.,LTD

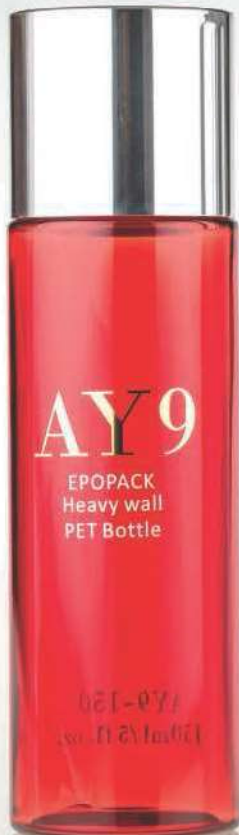

俊伸有限公司是一家優良的化妝品包裝材料製造商及供應商。擁有近30年之研發與製造經驗的我們，為全球客戶提供多樣且具高品質之化妝品容器。我們產品線包含PET厚瓶、100%消費者後端回收PET厚瓶、PET霜罐、SAN(AS)真空瓶以及PP真空瓶。並且，我們致力於提供客製化服務，滿足客戶之多樣需求。

我們已成功開發出一系列不同風格及造型的PET厚瓶，保存了玻璃所具有之透明度，以及PET瓶不易碎裂,安全,可回收之特性等。從2009年開始，我們全力投入100%消費者後端回收PET厚瓶之製作。此外2011年7月，獨家推出整組霜罐使用單一PET材質之產品。並於同年取得ISO 9001 及 ISO 14001 認證並獲頒驗證證書。

秉持著使用可節省能源與具永續性的包裝材料之使命，我們將持續開發環保與可回收的化妝品容器，並繼續提供令客戶滿意的產品服務。



EPOPACK Co., Ltd. is the leading manufacturer and outstanding supplier in the cosmetics packaging industry. With almost 30-year experiences in R&D as well as manufacturing, we offer high-quality PET/PCR PET heavy-wall bottles and jars, and vary material option airless bottles worldwide. We also provide custom-made services to meet our customers' needs.

Up to the present, we have successfully developed a variety of PET heavy-wall bottles with stylish and fashion design on bottle shapes, reinforcing the clarity of glass and remaining the shatter-proof property. Also, in Jul. 2011 we introduced PET heavy-wall jars, of which all the components are made from PET resins. Besides, we have been dedicated to developing 100% post consumer recycled (PCR) PET heavy-wall bottles since 2009.

EPOPACK CO., LTD. has ISO 9001 and ISO 14001 certification since 2011.

Upholding the mission to use energy-efficient and highly sustainable packaging materials to develop a wealth of cosmetic bottles, we will keep on supplying eco-friendly and recyclable cosmetics packaging as well as satisfactory customer services.

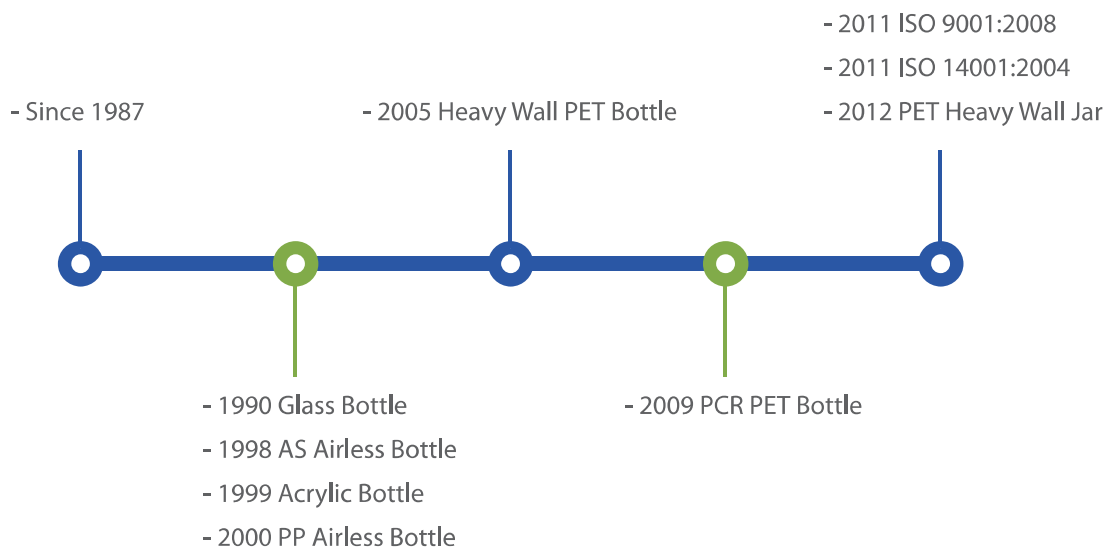

PET 厚壁瓶

PET Heavy Wall Bottle

Cylindrical 圓瓶

TR 系列 / TR SERIES	06
TD 系列 / TD SERIES	08
T28 系列 / T28 SERIES	08
AG 系列 / AG SERIES	09
AX 系列 / AX SERIES	09
AU, AV, AY 系列 / AU, AV, AY SERIES	10

Cone 錐型瓶

TC 系列 / TC SERIES	11
-------------------------	----

Water Drop 水滴瓶

TA 系列 / TA SERIES	12
-------------------------	----

Oval 橢圓瓶

TO 系列 / TO SERIES	12
-------------------------	----

Square 方瓶

TS 系列 / TS SERIES	13
TL 系列 / TL SERIES	13
AJ AK AL 系列 / AJ, AK, AL SERIES	14
AM 系列 / AM SERIES	14

Other 其他造型

AA, AB, AC, AD, AE, AF, AP 系列 / AA, AB, AC, AD, AE, AF, AP SERIES	15
AN, AO, AH 系列 / AN, AO, AH SERIES	16
TE, TF, TH, TI 系列 / TE, TF, TH, TI SERIES	17

消費者終端回收PET

PCR PET	18
---------------	----

真空瓶

Airless Bottle	19
----------------------	----

AS/SAN Material

A33 系列 / A33 SERIES	20
---------------------------	----

PETG Material

G 系列 / G SERIES	21
-----------------------	----

PP Material

P20 系列 / P20 SERIES	22
P24 系列 / P24 SERIES	22
P33 系列 / P33 SERIES	23

PET 厚壁罐

PET Heavy Wall Jar	24
--------------------------	----

MJA 系列 / MJA SERIES	25
---------------------------	----

EJ1 系列 / EJ1 SERIES	26
---------------------------	----

PJB 系列 / PJB SERIES	26
---------------------------	----

配件 / 裝飾

Components/Decoration

OPTIONAL COMPONENTS	27
---------------------------	----

PRODUCT REVIEW	28
----------------------	----

DECORATION OPTIONS	32
--------------------------	----

PET厚壁瓶為最理想之化妝品包材，不論是其材料特性亦或是厚壁質感，皆可在消費者的第一印象中將品牌價值強調出來。

Heavy-wall PET bottle is an ideal choice for cosmetics packaging because they are the most suitable cosmetic bottles from the product-quality, sustainable and intrinsic-property points of view:



材質特性

- 可回收之環保材質
- 高透明性
- 耐化學性
- 外加工容易且變化多
- 物理性良好: 強度夠，不易破碎

厚壁設計

- 保有看似玻璃的質感
- 低調奢華的風格

Material

- 100% recycled available
- High Transparency
- Good chemical resistance
- Easy for coloring and decorating
- Good physical properties

Heavy Wall Style

- Reinforce the impression of glass
- Luxury packaging

PET 厚壁瓶瓶型中 15ml,30ml及50ml產品皆可以指定使用更具環保意義的PCR PET材質生產
PCR PET material is available to apply for 15ml~50ml PET heavy wall bottles and jars



TR-15
15 ml



TR-30
30 ml



TR-50
50 ml



TR-75
75 ml



TR-100
100 ml



TR-120
120 ml



TR-150
150 ml

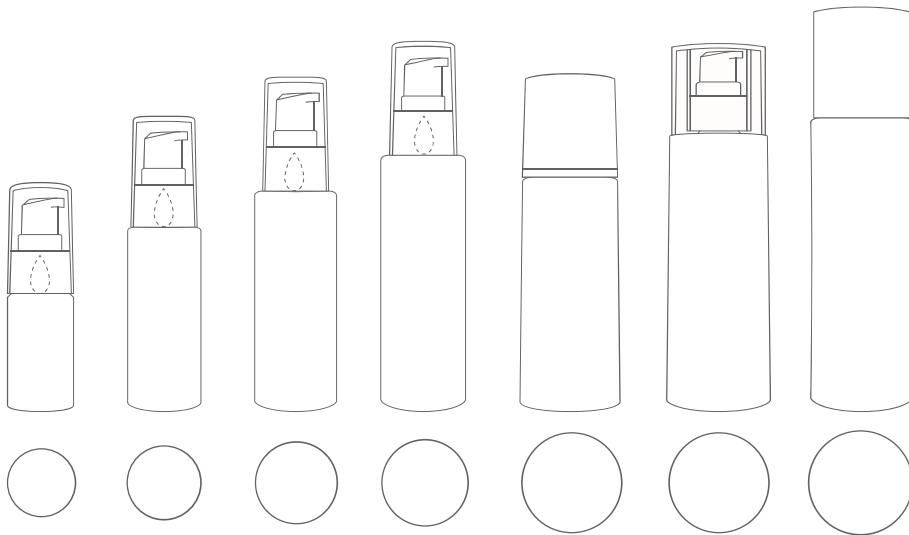



Dosage/壓頭輸出量: 0.22ml

Bottle material / 瓶身材質: PET / 100% PCR PET

ITEM	Full Vol. (ml)	Dia. (mm)	Ha (mm)	Hb (mm)	G.C.M.I.
品項	滿量	直徑	瓶高	總高	牙口
TR-15	19	28.0	62.0	73.7	20/410
TR-30	34	30.4	87.3	119.3	20/410
TR-50	60	34.0	103.5	135.5	20/410
TR-75	79	35.0	116.9	148.6	20/410
TR-100	105	41.0	108.5	136.6	20/410
TR-120	127	41.0	127.5	155.5	20/410
TR-150	157	42.0	143.0	171.8	20/410

Attachment 搭配配件	Pump+Cap 壓頭+上蓋						Reducer+screw cap 瓶口塞+旋蓋				Dropper 滴管	
	L1+EP2424	L1+EP3042	L1L+EP2845A	L2+EP2845	L2+CI2744	L2+EP4042	R20A + SC2416	R20A + SC2418	R20A + SC2430	R20A + SC2435	DP20	DM20
TR-15	○		○	○	○		○	○	○	○	○	○
TR-30	○	○	○	○	○		○	○	○	○	○	○
TR-50	○	○	○	○	○		○	○	○	○	○	○
TR-75	○	○	○	○	○		○	○	○	○		
TR-100	○	○	○	○	○	○	○	○	○	○		
TR-120	○	○	○	○	○	○	○	○	○	○		
TR-150	○	○	○	○	○	○	○	○	○	○		



TD-15
15 ml

TD-30
30 ml

TD-50
50 ml

T28-15
15 ml

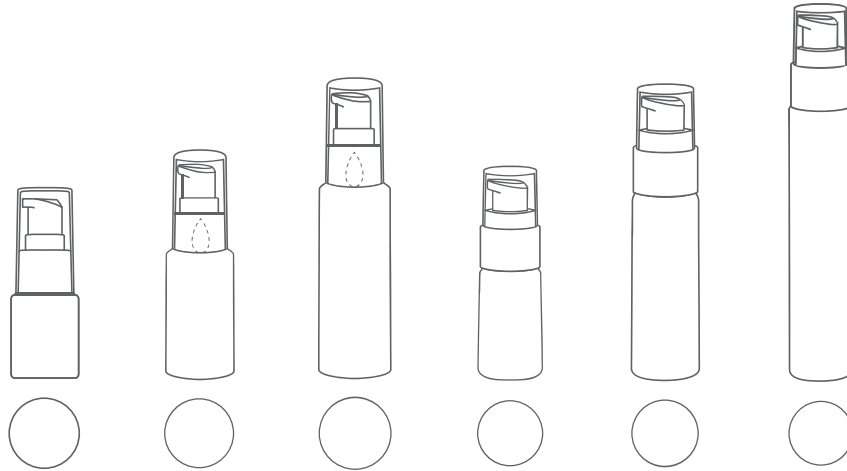
T28-30
30 ml

T28-50
50 ml

Dosage/壓頭輸出量:0.22ml

Bottle material / 瓶身材質: PET / 100% PCR PET

ITEM	Full Vol. (ml)	Dia. (mm)	Ha (mm)	Hb (mm)	G.C.M.I.
品項	滿量	直徑	瓶高	總高	牙口
TD-15	17.0	32.0	50.5	81.9	20/410
TD-30	40.0	33.0	74.3	105.9	20/410
TD-50	55.0	33.0	100.7	131.9	20/410
T28-15	19.0	28.0	62.0	90.9	20/410
T28-30	37.0	28.0	92.1	120.6	20/410
T28-50	55.0	28.0	136.1	164.8	20/410

Attachment 搭配配件	Pump + Cap 壓頭+上蓋						Reducer + screw cap 瓶口塞+旋蓋				Dropper 滴管	
	L1+EP2424	L1+EP3042	L1L+EP2845A	L2+EP2845	L2+CI2744	L5+EP2424	R20A + SC2416	R20A + SC2418	R20A + SC2430	R20A + SC2435	DP20	DM20
TD-15	<input type="checkbox"/>	<input type="checkbox"/>	<input type="checkbox"/>	<input type="checkbox"/>	<input type="checkbox"/>	<input type="checkbox"/>	<input type="checkbox"/>	<input type="checkbox"/>	<input type="checkbox"/>	<input type="checkbox"/>	<input type="checkbox"/>	<input type="checkbox"/>
TD-30	<input type="checkbox"/>	<input type="checkbox"/>	<input type="checkbox"/>	<input type="checkbox"/>	<input type="checkbox"/>	<input type="checkbox"/>	<input type="checkbox"/>	<input type="checkbox"/>	<input type="checkbox"/>	<input type="checkbox"/>	<input type="checkbox"/>	<input type="checkbox"/>
TD-50	<input type="checkbox"/>	<input type="checkbox"/>	<input type="checkbox"/>	<input type="checkbox"/>	<input type="checkbox"/>	<input type="checkbox"/>	<input type="checkbox"/>	<input type="checkbox"/>	<input type="checkbox"/>	<input type="checkbox"/>	<input type="checkbox"/>	<input type="checkbox"/>
T28-15	<input type="checkbox"/>	<input type="checkbox"/>	<input type="checkbox"/>	<input type="checkbox"/>	<input type="checkbox"/>	<input type="checkbox"/>	<input type="checkbox"/>	<input type="checkbox"/>	<input type="checkbox"/>	<input type="checkbox"/>	<input type="checkbox"/>	<input type="checkbox"/>
T28-30	<input type="checkbox"/>	<input type="checkbox"/>	<input type="checkbox"/>	<input type="checkbox"/>	<input type="checkbox"/>	<input type="checkbox"/>	<input type="checkbox"/>	<input type="checkbox"/>	<input type="checkbox"/>	<input type="checkbox"/>	<input type="checkbox"/>	<input type="checkbox"/>
T28-50	<input type="checkbox"/>	<input type="checkbox"/>	<input type="checkbox"/>	<input type="checkbox"/>	<input type="checkbox"/>	<input type="checkbox"/>	<input type="checkbox"/>	<input type="checkbox"/>	<input type="checkbox"/>	<input type="checkbox"/>	<input type="checkbox"/>	<input type="checkbox"/>

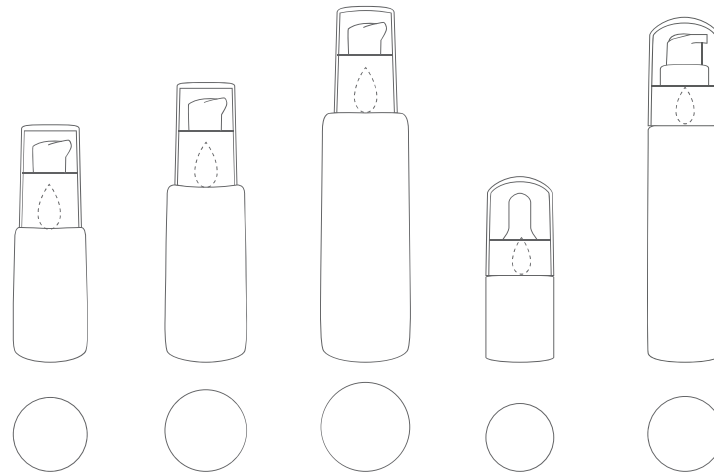

Dosage/壓頭輸出量: 0.22ml

Bottle material / 瓶身材質: PET / 100% PCR PET

ITEM	Full Vol. (ml)	Dia. (mm)	Ha (mm)	Hb (mm)	G.C.M.I.
品項	滿量	直徑	瓶高	總高	牙口
AG4-030	33.0	32.9	70.3	101.8	20/410
AG6-050	53.0	36.0	88.5	119.9	20/410
AG7-100	102.0	39.3	121.1	152.7	20/410
AX4-018	20.0	32.5	53.8	87.1	20/410
AX6-060	66.0	32.5	116.9	150.1	20/410

Attachment 搭配配件	Pump + Cap 壓頭+上蓋						Reducer + screw cap 瓶口塞+旋蓋				Dropper 滴管		
	L1+EP2424	L1+EP3042	L1L+EP2845A	L2+EP2845	L2+CI2744	L6+EP3247	R20A + SC2416	R20A + SC2418	R20A + SC2430	R20A + SC2435	DL20+EP3247	DP20	DM20
AG4-030	○	○	○	○	○	○	○	○	○	○	○	○	○
AG6-050	○	○	○	○	○	○	○	○	○	○	○	○	○
AG7-100	○	○	○	○	○	○	○	○	○	○	○	○	○
AX4-018	○	○	○	○	○	○	○	○	○	○	○	○	○
AX6-060	○	○	○	○	○	○	○	○	○	○	○	○	○

 AU7-120
120 ml

 AV7-120
120 ml

 AV7-150
150 ml

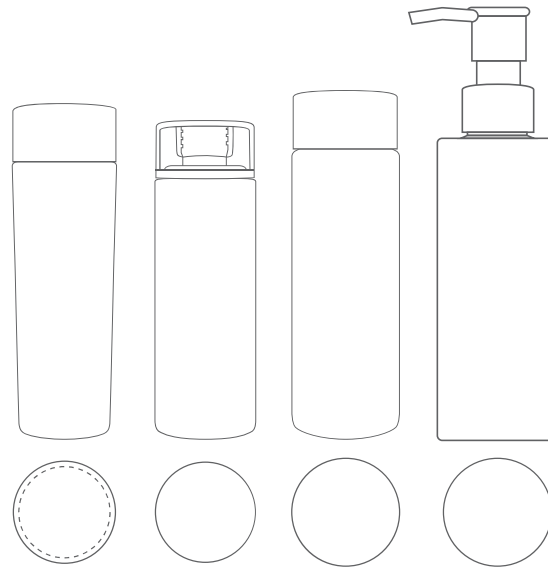
 AY9-150
150 ml

Dosage / 壓頭輸出量: 0.22ml or 0.5ml

Bottle material / 瓶身材質: PET

ITEM	Full Vol. (ml)	Dia. (mm)	Ha (mm)	Hb (mm)	G.C.M.I.
品項	滿量	直徑	瓶高	總高	牙口
AU7-120	127.0	43.7	130.6	124.0	20/410
AV7-120	124.0	41.7	122.9	128.7	20/410
AV7-150	156.0	43.7	132.9	138.7	20/410
AY9-150	157.0	45.0	134.0	169.0	24/410
AY9-150+D1	157.0	45.0	134.0	168.6	24/410
AY9-150+SC4340	157.0	45.0	134.0	169.0	24/410

Attachment 搭配配件	Pump + Cap 壓頭+上蓋			Reducer + screw cap 瓶口塞+旋蓋			
	B6	D1	B2+EP3044	R24A+SC4340	SC4124	SC4324	R20B
AU7-120							
AV7-120					○	○	○
AV7-150						○	○
AY9-150	○	○	○	○			

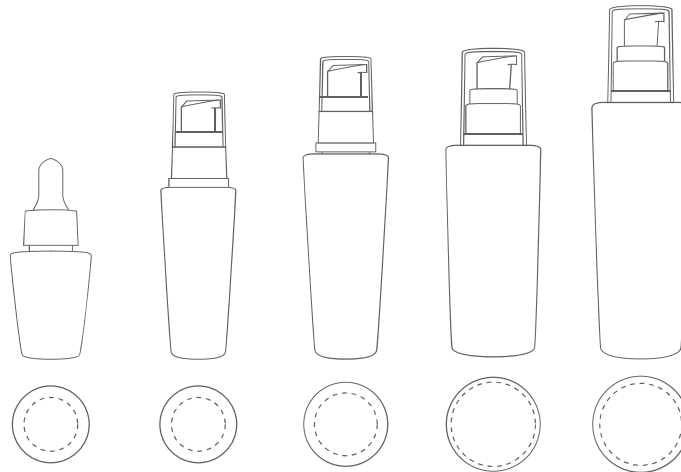

Dosage/壓頭輸出量:0.22ml

Bottle material / 瓶身材質: PET / 100% PCR PET

ITEM	Full Vol. (ml)	Dia. (mm)	Ha (mm)	Hb (mm)	G.C.M.I.
品項	滿量	直徑	瓶高	總高	牙口
TC-15	19.0	34.1	58.2	82.3	20/410
TC-30	34.0	34.1	90.7	119.7	20/410
TC-50	61.0	38.1	106.0	135.0	20/410
TC-100	105.0	44.0	108.8	137.2	20/410
TC-120	127.0	44.7	126.7	156.3	20/410

Attachment 搭配配件	Pump + Cap 壓頭+上蓋					Reducer + screw cap 瓶口塞+旋蓋				Dropper 滴管	
	L1+EP2424	L1+EP3042	L1L+EP2845A	L2+EP2845	L2+CI2744	R20A + SC2416	R20A + SC2418	R20A + SC2430	R20A + SC2435	DP20	DM20
TC-15	○		○	○	○	○	○	○	○	○	○
TC-30	○	○	○	○	○	○	○	○	○	○	○
TC-50	○	○	○	○	○	○	○	○	○	○	○
TC-100	○	○	○	○	○	○	○	○	○	○	○
TC-120	○	○	○	○	○	○	○	○	○	○	○

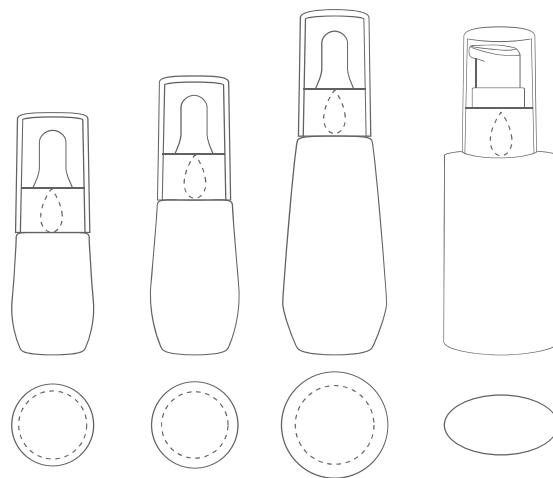

Dosage/壓頭輸出量: 0.22ml

Bottle material/瓶身材質: PET / 100% PCR PET

ITEM	Full Vol. (ml)	Dia. (mm)	Ha (mm)	Hb (mm)	G.C.M.I.
品項	滿量	直徑	瓶高	總高	牙口
TA-15	21	18.6	59.9	91.4	20/410
TA-30	35	19.4	71.7	103.5	20/410
TA-50	57	20.4	87.6	126.5	20/410
TO-50	57	42.7	42.8	119.3	20/410

Attachment	Pump+Cap 壓頭+上蓋					Reducer+screw cap 瓶口塞+旋蓋				Dropper 滴管	
搭配配件	L1+EP2424	L1+EP3042	L1L+EP2845A	L2+EP2845	L2+CI2744	R20A + SC2416	R20A + SC2418	R20A + SC2430	R20A + SC2435	DP20	DM20
TA-15	○	○	○	○	○	○	○	○	○	○	○
TA-30	○	○	○	○	○	○	○	○	○	○	○
TA-50	○	○	○	○	○	○	○	○	○	○	○
TO-50	○	○	○	○	○	○	○	○	○	○	○

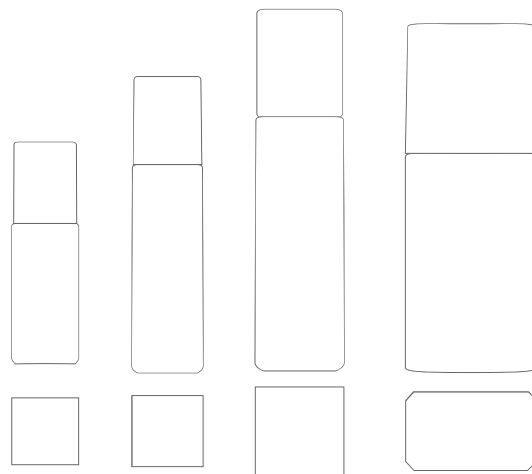

Dosage/壓頭輸出量:0.22ml

Bottle material / 瓶身材質: PET / 100% PCR PET

ITEM	Full Vol. (ml)	Dia. (mm)	Ha (mm)	Hb (mm)	G.C.M.I.
品項	滿量	直徑	瓶高	總高	牙口
TS-60	70.0	34.5	88.0	114.6	20/410
TS-90	100.0	34.5	116.0	143.2	20/410
TS-200	217.0	43.5	148.0	176.8	24/410
TL-200	215.0	60.8	128.2	161.0	24/410

Attachment 搭配配件	Pump+Cap 壓頭+上蓋			
	L2A1	L2A2BCS	B2A1	B2A2BCS
TS-60	○	○		
TS-90	○	○		
TS-200			○	○
TL-200			○	○

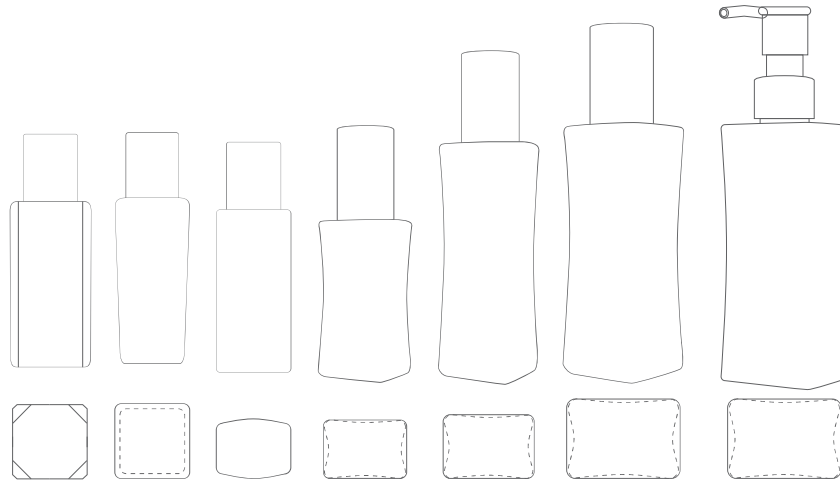

Dosage/壓頭輸出量: 0.22ml or 0.5ml

Bottle material / 瓶身材質: PET / 100% PCR PET

ITEM	Full Vol. (ml)	Dia. (mm)	Ha (mm)	Hb (mm)	G.C.M.I.
品項	滿量	直徑	瓶高	總高	牙口
AJ6-050	53.0	34.0	85.9	104.5	20/410
AK6-050	53.0	34.0	91.1	102.6	20/410
AL6-050	53.0	35.0	87.5	108.4	20/410
AM6-050	55.0	35.8	88.4	116.0	20/410
AM7-100	104.0	39.1	124.6	152.5	20/410
AM9-150	155.0	44.8	132.5	159.5	24/410
AM9-150+D1	155.0	44.8	132.5	166.8	24/410

Attachment	Pump + Cap 壓頭+上蓋						Reducer + screw cap 瓶口塞+旋蓋				Dropper 滴管				
	搭配配件	L1+EP2424	L1+EP3042	L1L+EP2845A	L2+EP2845	L2+CI2744	B2+EP3044	B6	D1	R20A + SC2416	R20A + SC2418	R20A + SC2430	R20A + SC2435	DM20	DP20
AJ6-050															
AK6-050	<input type="checkbox"/>	<input type="checkbox"/>	<input type="checkbox"/>	<input type="checkbox"/>	<input type="checkbox"/>	<input type="checkbox"/>	<input type="checkbox"/>	<input type="checkbox"/>	<input type="checkbox"/>	<input type="checkbox"/>	<input type="checkbox"/>	<input type="checkbox"/>	<input type="checkbox"/>	<input type="checkbox"/>	<input type="checkbox"/>
AL6-050	<input type="checkbox"/>	<input type="checkbox"/>	<input type="checkbox"/>	<input type="checkbox"/>	<input type="checkbox"/>	<input type="checkbox"/>	<input type="checkbox"/>	<input type="checkbox"/>	<input type="checkbox"/>	<input type="checkbox"/>	<input type="checkbox"/>	<input type="checkbox"/>	<input type="checkbox"/>	<input type="checkbox"/>	<input type="checkbox"/>
AM6-050	<input type="checkbox"/>	<input type="checkbox"/>	<input type="checkbox"/>	<input type="checkbox"/>	<input type="checkbox"/>	<input type="checkbox"/>	<input type="checkbox"/>	<input type="checkbox"/>	<input type="checkbox"/>	<input type="checkbox"/>	<input type="checkbox"/>	<input type="checkbox"/>	<input type="checkbox"/>	<input type="checkbox"/>	<input type="checkbox"/>
AM7-100	<input type="checkbox"/>	<input type="checkbox"/>	<input type="checkbox"/>	<input type="checkbox"/>	<input type="checkbox"/>	<input type="checkbox"/>	<input type="checkbox"/>	<input type="checkbox"/>	<input type="checkbox"/>	<input type="checkbox"/>	<input type="checkbox"/>	<input type="checkbox"/>	<input type="checkbox"/>	<input type="checkbox"/>	<input type="checkbox"/>
AM9-150	<input type="checkbox"/>	<input type="checkbox"/>	<input type="checkbox"/>	<input type="checkbox"/>	<input type="checkbox"/>	<input type="checkbox"/>	<input type="checkbox"/>	<input type="checkbox"/>	<input type="checkbox"/>	<input type="checkbox"/>	<input type="checkbox"/>	<input type="checkbox"/>	<input type="checkbox"/>	<input type="checkbox"/>	<input type="checkbox"/>

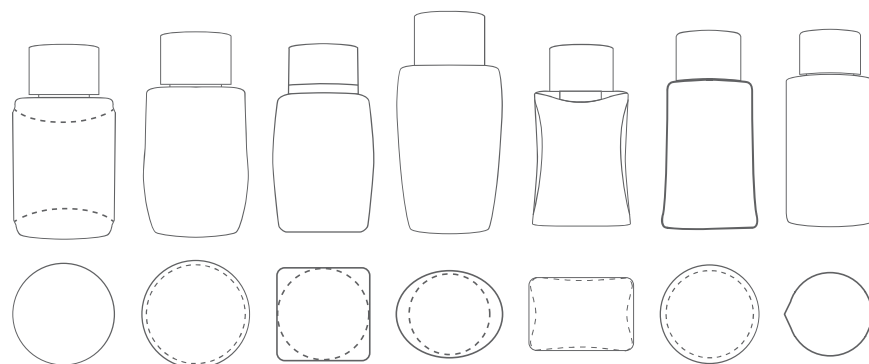

Dosage/壓頭輸出量: 0.22ml

Bottle material / 瓶身材質: PET / 100% PCR PET

ITEM	Full Vol. (ml)	Dia. (mm)	Ha (mm)	Hb (mm)	G.C.M.I.
品項	滿量	直徑	瓶高	總高	牙口
AA4-030	33.0	35.8	62.1	67.6	20/410
AB4-030	33.0	35.6	64.2	69.7	20/410
AC4-030	33.0	33.6	59.9	64.0	20/410
AD4-030	34.0	36.5	70.2	75.3	20/410
AE4-030	32.0	37.0	63.7	68.7	20/410
AF4-030	33.0	35.5	68.1	73.2	20/410
AP4-030	35.0	34.6	71.5	75.6	20/410

Attachement	Pump/Cap 押頭/上蓋					Reducer/screw cap 瓶口塞/旋蓋				Dropper 滴管	
	搭配配件	L1+EP2424	L1+EP3042	L1L+EP2845A	L2+EP2845	L2+CI2744	R20A + SC2416	R20A + SC2418	R20A + SC2430	R20A + SC2435	DP20
AA4-030											
AB4-030	o	o	o	o	o	o	o	o	o	o	o
AC4-030	o	o	o	o	o	o	o	o	o	o	o
AD4-030	o	o	o	o	o	o	o	o	o	o	o
AE4-030	o	o	o	o	o	o	o	o	o	o	o
AF4-030	o	o	o	o	o	o	o	o	o	o	o
AP4-030	o	o	o	o	o	o	o	o	o	o	o



Dosage/壓頭輸出量: 0.22ml or 0.5 ml

Bottle material / 瓶身材質: PET / 100% PCR PET

ITEM	Full Vol. (ml)	Dia. (mm)	Ha (mm)	Hb (mm)	G.C.M.I.
品項	滿量	直徑	瓶高	總高	牙口
AN6-050	55.0	37.0	95.2	126.4	20/410
AN7-100	104.0	40.0	132.7	164.1	20/410
AN9-150	155.0	48.0	136.5	165.3	24/410
AN9-150 + D1	155.0	48.0	136.5	170.92	24/410
AO4-015	19.0	30.7	54.7	78.7	20/410
AO6-050	55.0	34.1	104.5	132.4	20/410
AO7-100	104.0	39.3	130.9	159.1	20/410
AO9-150	153.0	46.4	137.3	172.0	24/410

Attachment	Pump+Cap 壓頭+上蓋							Reducer+screw cap 瓶口塞+旋蓋					Dropper 滴管		
	L1+EP2424	L1+EP3042	L1L+EP2845A	L2+EP2845	L2+CI2744	B2+EP3044	B6	D1	R20A + SC2416	R20A + SC2418	R20A + SC2430	R20A + SC2435	R24A + SC4340	DP20	DM20
AN6-050	<input type="checkbox"/>	<input type="checkbox"/>	<input type="checkbox"/>	<input type="checkbox"/>	<input type="checkbox"/>	<input type="checkbox"/>	<input type="checkbox"/>	<input type="checkbox"/>	<input type="checkbox"/>	<input type="checkbox"/>	<input type="checkbox"/>	<input type="checkbox"/>	<input type="checkbox"/>	<input type="checkbox"/>	<input type="checkbox"/>
AN7-100	<input type="checkbox"/>	<input type="checkbox"/>	<input type="checkbox"/>	<input type="checkbox"/>	<input type="checkbox"/>	<input type="checkbox"/>	<input type="checkbox"/>	<input type="checkbox"/>	<input type="checkbox"/>	<input type="checkbox"/>	<input type="checkbox"/>	<input type="checkbox"/>	<input type="checkbox"/>	<input type="checkbox"/>	<input type="checkbox"/>
AN9-150	<input type="checkbox"/>	<input type="checkbox"/>	<input type="checkbox"/>	<input type="checkbox"/>	<input type="checkbox"/>	<input type="checkbox"/>	<input type="checkbox"/>	<input type="checkbox"/>	<input type="checkbox"/>	<input type="checkbox"/>	<input type="checkbox"/>	<input type="checkbox"/>	<input type="checkbox"/>	<input type="checkbox"/>	<input type="checkbox"/>
AO4-015	<input type="checkbox"/>	<input type="checkbox"/>	<input type="checkbox"/>	<input type="checkbox"/>	<input type="checkbox"/>	<input type="checkbox"/>	<input type="checkbox"/>	<input type="checkbox"/>	<input type="checkbox"/>	<input type="checkbox"/>	<input type="checkbox"/>	<input type="checkbox"/>	<input type="checkbox"/>	<input type="checkbox"/>	<input type="checkbox"/>
AO6-050	<input type="checkbox"/>	<input type="checkbox"/>	<input type="checkbox"/>	<input type="checkbox"/>	<input type="checkbox"/>	<input type="checkbox"/>	<input type="checkbox"/>	<input type="checkbox"/>	<input type="checkbox"/>	<input type="checkbox"/>	<input type="checkbox"/>	<input type="checkbox"/>	<input type="checkbox"/>	<input type="checkbox"/>	<input type="checkbox"/>
AO7-100	<input type="checkbox"/>	<input type="checkbox"/>	<input type="checkbox"/>	<input type="checkbox"/>	<input type="checkbox"/>	<input type="checkbox"/>	<input type="checkbox"/>	<input type="checkbox"/>	<input type="checkbox"/>	<input type="checkbox"/>	<input type="checkbox"/>	<input type="checkbox"/>	<input type="checkbox"/>	<input type="checkbox"/>	<input type="checkbox"/>
AO9-150	<input type="checkbox"/>	<input type="checkbox"/>	<input type="checkbox"/>	<input type="checkbox"/>	<input type="checkbox"/>	<input type="checkbox"/>	<input type="checkbox"/>	<input type="checkbox"/>	<input type="checkbox"/>	<input type="checkbox"/>	<input type="checkbox"/>	<input type="checkbox"/>	<input type="checkbox"/>	<input type="checkbox"/>	<input type="checkbox"/>

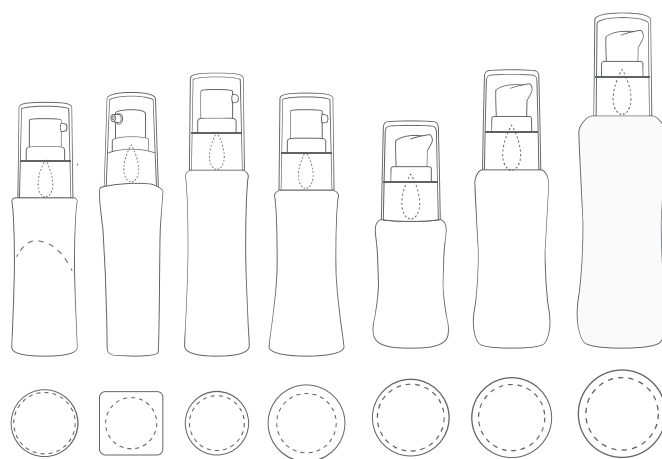

Dosage/壓頭輸出量: 0.22ml

Bottle material / 瓶身材質: PET / 100% PCR PET

ITEM	Full Vol. (ml)	Dia. (mm)	Ha (mm)	Hb (mm)	G.C.M.I.
品項	滿量	直徑	瓶高	總高	牙口
TE-30	34.0	33.4	88.1	129.6	20/410
TF-30	33.0	29.9	97.3	120.3	20/410
TH-30	41.0	31.4	99.8	133.9	20/410
TI-30	43.0	36.4	90.4	124.9	20/410
AH4-030	33.0	35.5	72.0	103.6	20/410
AH6-050	54.0	37.5	93.7	127.3	20/410
AH7-100	104.0	43.3	119.2	151.0	20/410

Attachment	Pump+Cap 壓頭+上蓋					Reducer+screw cap 瓶口塞+旋蓋				Dropper 滴管		
	搭配配件	L1+EP2424	L1+EP3042	L1L+EP2845A	L2+EP2845	L2+CI2744	R20A+SC2416	R20A+SC2418	R20A+SC2430	R20A+SC2435	DP20	DM20
TE-30		○	○	○	○	○	○	○	○	○	○	○
TF-30		○	○	○	○	○	○	○	○	○	○	○
TH-30		○	○	○	○	○	○	○	○	○	○	○
TI-30		○	○	○	○	○	○	○	○	○	○	○
AH4-030		○	○	○	○	○	○	○	○	○	○	○
AH6-050		○	○	○	○	○	○	○	○	○	○	○
AH7-100		○	○	○	○	○	○	○	○	○	○	○

消費者終端回收PET

俊伸有限公司亦提供 PCR PET 材質製作的厚壁瓶及厚壁霜罐，此系列產品提供兼具美觀及環保意識的回收再生綠色包材，使用消費者終端回收 PET 材質再製成瓶，100% 使用再生原料堅持為環境盡最大的心力，與協力夥伴-大愛感恩科技股份有限公司共同打造環保與美的最佳代言人。PET 厚壁瓶瓶型中15ml, 30ml 50ml產品皆可以 PCR PET 製造提供。

ABOUT PCR - PET

By using 100% post-consumer recycled PET plastic, we are able to build the brand image in "Green". The process begins with the collection of used plastic bottle by the Buddhist Tzu Chi Foundation. Founded in 1966, the Tzu Chi Foundation is one of the largest charity organizations originating from Taiwan. There are approximately 5,400 Tzu Chi recycling stations in Taiwan and nearly 2,000 tons of PET bottles are collected and recycled by the over 72,000 Tzu Chi volunteers each year. The volunteers carefully follow the below process to recycled PET bottle one by one. This material will be available to apply for 15ml~ 50ml PET heavy wall bottle/ jar.

回收及分類過程 Recycling and Sorting Process



PET 厚壁瓶瓶型中 15ml,30ml 及50ml產品皆可以指定使用更具環保意義的PCR PET材質生產

PCR PET material is available to apply for 15ml~50ml PET heavy wall bottles and jars

真空瓶

不同材質的真空瓶包材提供客戶不同設計的樣式及視內料之需求選擇適合的瓶器。穩定的品質服務及優良的產品設計塑造專業的品牌形象。低殘留量的優點讓最後一滴也不浪費。

AIRLESS BOTTLE

With a variety of materials to choose from, airless bottles provide more options for design and formula. Perfect quality and stylish; it creates a professional feature and image for brand value. The airless bottle system ensures that even the last drop of lotion in the bottle is reachable.



材質特性

- PP/AS/PETG 等多材質選擇
- 低殘留量
- 耐化學性
- 外加工容易且變化多
- 適用於各種內料產品

Material

- PP/AS/PETG material options
- Low residue amount
- Good chemical resistance
- Easy for coloring and decorating
- Apply in wide range formula



A33-15
15 ml



A33-30
30 ml



A33-50
50 ml



ITEM	Full Vol. (ml)	Dia. (mm)	Ha (mm)	Hb (mm)	G.C.M.I.
品項	滿量	直徑	瓶高	總高	牙口
A33-15	22.0	33.3	63.7	91.4	20/410
A33-30	39.0	33.3	95.0	122.6	20/410
A33-50	57.0	33.3	123.5	151.2	20/410

Part	Material
Cap	AS
Actuator	PP / Aluminum
Pump	PP / Aluminum
Bottle	AS
Base	Aluminum

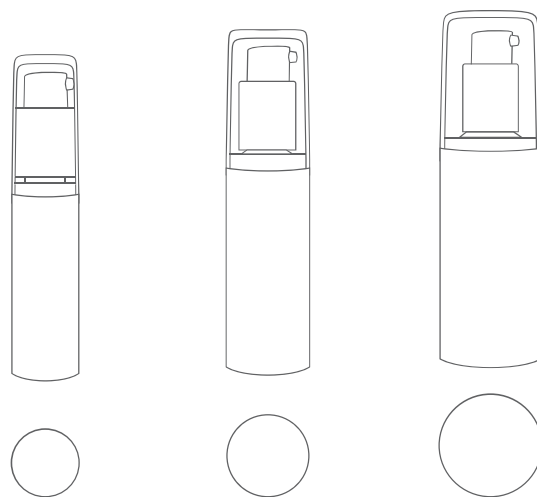

ITEM	Full Vol. (ml)	Dia. (mm)	Ha (mm)	Hb (mm)	G.C.M.I.
品項	滿量	直徑	瓶高	總高	牙口
G24-15	18	24.7	85.6	115.2	18/415
G30-30	32	30.6	93.4	121.7	18/415
G37-50	56	37.8	97.7	127.3	18/415

Part	Material
Cap	AS
Pump	Aluminum
Bottle	PETG
Base	ABS

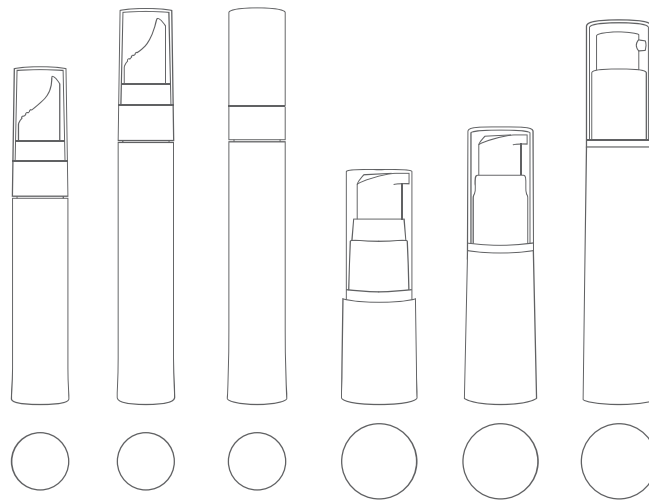

ITEM 品項	Full Vol. (ml) 滿量	Dia. (mm) 直徑	Ha (mm) 瓶高	Hb (mm) 總高	G.C.M.I. 牙口
P20-10	14	21.0	87.6	120.8	18/400
P20-15	17	21.0	87.6	140.4	18/400
P20-18	20	21.0	107.6	140.4	18/400
P24-07	11	25.6	50.3	78.8	18/415
P24-15	18	25.6	71.0	99.2	18/415
P24-30	34	25.6	110.5	138.2	18/415

Part	Material
Cap	AS / PP
Actuator	PP / Aluminum
Pump	PP / Aluminum
Bottle	PP

Attachment 搭配配件	Pump+Cap 壓頭+上蓋		
	C1	C2	C2L
P24-07	○	○	○
P24-15	○	○	○
P24-30	○	○	○





P33-15
15 ml

P33-30
30 ml

P33-50
50 ml



ITEM	Full Vol. (ml)	Dia. (mm)	Ha (mm)	Hb (mm)	G.C.M.I.
品項	滿量	直徑	瓶高	總高	牙口
P33-15	24	32.6	66.0	96.3	20/410
P33-30	37	32.6	87.8	118.0	20/410
P33-50	59	32.6	121.0	151.2	20/410

Part	Material
Cap	AS
Actuator	PP / Aluminum
Pump	PP / ABS / Aluminum
Bottle	PP

Attachment	Pump+Cap 壓頭+上蓋			
搭配配件	L1	L1L	L2	L2L
P33-15	○	○	○	○
P33-30	○	○	○	○
P33-50	○	○	○	○

PET厚壁罐重新定義的環保包材，單一材質的設計理念，使包材在使用完畢後易於回收。此系列全透明的設計更可讓產品全方位的展示其顏色及產品質地。

Heavy-Wall PET Jar redefined eco-friendly packaging. The idea that "single material packaging" produced a three-components jar in PET material only. This green spirit the Heavy-Wall PET Jar conveys encourages recycling and simplifies the recycling process. All transparent components is the bonus for this range, providing a 360 degree see-through view, making color and texture 100% visible.



材質特性

- 可回收之環保材質
- 高透明性
- 耐化學性
- 外加工容易且變化多
- 物理性良好: 強度高，不易破碎

厚壁設計

- 保有看似玻璃的質感
- 低調奢華的風格

Material

- 100% recycled available
- High Transparency
- Good chemical resistance
- Easy for coloring and decorating
- Good physical properties

Heavy Wall Style

- Reinforce the impression of glass
- Luxury packaging

PET 全系列皆可指定使用更具環保意義的"消費者終端回收PET"

All our stylish PET cosmetic jars can be made from PCR PET resins as well



MJA-10A
10 ml

MJA-15A
15 ml

MJA-30A
30 ml

MJA-50A
50 ml

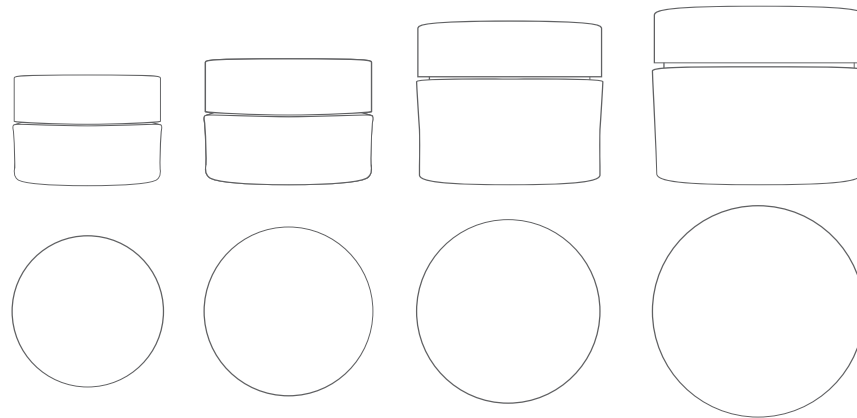

ITEM	Full Vol. (ml)	Dia. (mm)	Ha (mm)	Hb (mm)	G.C.M.I.	Part	Material
品項	滿量	直徑	瓶高	總高	牙口	Cap	PET / 100% PCR PET
MJA-10A	12.0	40.5	24.8	28.8	35/400	Lid	PET / 100% PCR PET
MJA-15A	17.0	44.0	28.0	31.2	38/400	Base	PET / 100% PCR PET
MJA-30A	34.0	48.5	36.7	40.1	43/415		
MJA-50A	58.0	57.2	41.0	44.3	52/400		

 EJ1-30
30 ml

 EJ1-30
30 ml

 PJA-007
7 ml

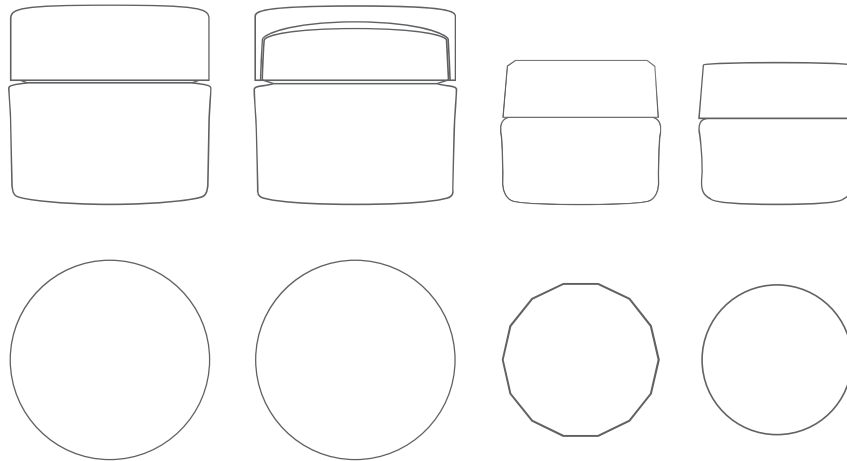
 PJB-007
7 ml

ITEM	Full Vol. (ml)	Dia. (mm)	Ha (mm)	Hb (mm)	G.C.M.I.
品項	滿量	直徑	瓶高	總高	牙口
EJ1-30	34	51.01	40.1	49.6	43/415
PJA-007	7	31.11	23.5	27.5	26
PJB-007	7	31.11	23.5	27.5	26

Part	EJ1-30Material
Inner/Outer Cap	PET / 100% PCR PET
Lid	PET / 100% PCR PET
Base	PET / 100% PCR PET

Part	PJA / PJB Material
Cap/liner PP/PE	PP
Base	PP



Pump+Cap 壓頭+上蓋 Option: G.C.M.I. 20/4 10



L1/EP2424



L1/EP3042



L1L/EP2845A



L2/EP2845



L2/EP4042



L2L/EP2845



L7/EP2845



L2/CI2744



L5/EP2424



L6/EP3247

Reducer+screw cap 瓶口塞+旋蓋 / Dropper+wiper 滴管+滴管内塞 : G.C.M.I. 20/4 10

24/4 10



SC2416



SC2430



W20A



DM20



DP20



B6



D1



SC2418



SC2435



R20A



DM20



DP20



B2/EP3044



SC4340



R24A

Actuator



A1



A2BCS



A3MP



A3MPS



A5



A9

PET Heavy Wall Bottle



TR-15
15 ml



T28-15
15 ml



AX3-020
20 ml



TC-15
15 ml



TA-15
15 ml



TD-15
15 ml



AO4-015
50 ml

Airelss Bottle



A33-15
15 ml



G24-15
15 ml



P20-10
10 ml



P20-15
15 ml



P20-18
18 ml



P24-7
7 ml



P24-15
15 ml



P33-15
15 ml

PET Heavy Wall Jar



MJA-10A
10 ml



MJA-15A
15 ml



PJA-007
7 ml



PJB-007
7 ml



PET Heavy Wall Bottle



TR-30
30 ml



TD-30
30 ml



T28-30
30 ml



AG4-030
30 ml



TC-30
30 ml



TA-30
30 ml



AA4-030
30 ml



AB4-030
30 ml



AC4-030
30 ml



AD4-030
30 ml



AE4-030
30 ml



AF4-030
30 ml



AP4-030
30 ml



AH4-030
30 ml



TE-30
30 ml



TF-30
30 ml



TH-30
30 ml



TI-30
30 ml

Airelss Bottle



A33-30
30 ml



G30-30
30 ml



P24-30
30 ml



P33-30
30 ml

PET Heavy Wall Jar



MJA-30A
30 ml



EJ1-30
30 ml

PET Heavy Wall Bottle



TR-50
50 ml

TD-50
55 ml

T28-50
50 ml

AG6-050
50 ml

TC-50
50 ml

TA-50
50 ml

TO-50
50 ml

AJ6-050
50 ml

AK6-050
50 ml

AL6-050
50 ml

AM6-050
50 ml

AN6-050
50 ml

AO6-050
50 ml

AH6-050
50 ml

Airelss Bottle



A33-50
50 ml

G37-50
50 ml

P33-50
50 ml

PET Heavy Wall Jar



MJA-50A
50 ml

PET Heavy Wall Bottle



TR-75
75 ml



TR-100
100 ml



TR-120
120 ml



TR-150
150 ml



AG7-100
100 ml



AX6-060
60 ml



TC-100
100 ml



TC-120
120 ml



TS-60
60 ml



TS-90
90 ml



TS-200
200 ml



TL-200
200 ml



AM7-100
100 ml



AM9-150
150 ml



AN7-100
100 ml



AN9-150
150 ml



AO7-100
100 ml



AO9-150
150 ml



AH7-100
100 ml



AU7-120
120 ml



AV7-120
120 ml



AV7-150
150 ml



AY9-150
150 ml

BOTTLE / coating, printing, hot stamping, injection color, vacuum plating

CAP / coating, printing, hot stamping, injection color, vacuum plating

ACTUATOR / injection color

PUMP, COLLAR / gold, silver, custom color, vacuum plating



PRINTING

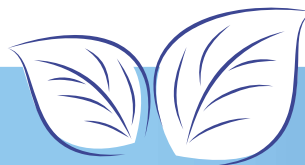

COLOR INJECTION



HOT STAMPING

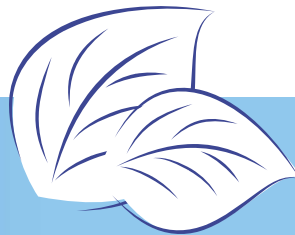

SPRAY PAINTING



俊伸有限公司
EPOPACK CO.,LTD

NO.2-5, NANYUAN RD., ZHONGLI DIST., TAOYUAN CITY 320, TAIWAN (R.O.C.)
台灣桃園市中壢區南園路2-5號 | 電話 (TEL) : +886 3 4631598 | 傳真 (FAX) : +886 3 4631511
E-MAIL: INFO@EPOPACK.COM WEB: WWW.EPOPACK.COM